

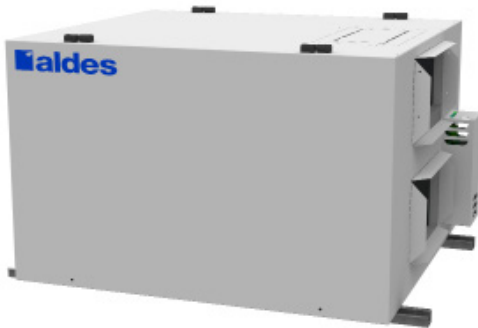

Intertek
C22.2 no113
UL 1812



LIGHT COMMERCIAL SERIES

ERV

E1100L-Fi-N

Energy Recovery Ventilator
1100 CFM at 0.4 in.w.g (ESP)



CORE

OTHER PARTS

PRODUCT DESCRIPTION

The E1100L-Fi-N energy recovery ventilator provides up to 1100 cubic feet per minute (520 L/s) of fresh outdoor air while exhausting an equivalent amount of stale indoor air, creating a well-balanced ventilation system. The E1100L-Fi-N makes use of Aldes' AHRI Certified High Latent Transfer enthalpic cores that deliver superior moisture transfer and can be used in any climate zone.

The E1100L-Fi-N is recommended for midsized non-residential spaces or dedicated zones within larger buildings such as classrooms, common areas of residential complexes and indoor parking garages.

Designed for versatile indoor installation, Aldes light commercial ventilators can fit almost anywhere and still provide easy access to the internal components for quick maintenance. The units also offer a choice of five continuous operation speeds and a demand-controlled high speed exchange mode.

KEY FEATURES

Electronically and independently adjustable supply and exhaust blowers (FlexControl).

Painted, heavy-gauge galvanized steel cabinets are attractive, rust-resistant and extremely durable.

Doors on both sides of the unit to allow easy access to filters, cores and motors, no matter the installation constraints.

Fan exhaust frost protection, or optional recirculation defrost kit (factory installed or upgraded in the field).

Four efficient, totally enclosed motors with backward inclined impellers.

Durable High Latent Transfer enthalpy core has exceptional moisture transfer for increased comfort.



Plate Exchanger

Material: High latent transfer (HLT)

Casing

Material: Painted galvanized steel 22GA
Insulation: 1"(25 mm) Fiberglass with FSK
Drain Connection: Ø 1/2" (Ø 13 mm)
Duct Connections: 20" x 8" (508mm x 203mm)
Width: 36-1/4" (921mm)
Height: 23-7/8" (606mm)
Depth: 47-1/4" (1200mm)
Unit Weight: 206 lb (93 kg); 216 lb (97 kg) with recirculation
Shipping Weight: 261 lb (118 kg); 271 lb (193 kg) with recirculation



Mounting

Supplied with base rails. Support rods not included.



Electrical Requirements

120V/1p/60 Hz: FLA 8.2A, MCA 8.7A, MOP 15A
Terminal block for direct wiring to the building's electrical system.
Fused disconnect not included.



Frost Control

Cycles controlled by a temperature sensor when outdoor temperatures fall below 14°F (-10°C).

- Standard: Exhaust Defrost
- Optional: Recirculation Defrost (P/N 683950)



Blowers

Four backward-inclined motorized impeller, direct-drive PSC, variable speed, external rotor



Filters

Filter Type	Additional Air Pressure Drop with Optional Filters	
	Airflow CFM (L/S)	
	500 (236)	1100 (520)
	MERV 8	0.04 0.15
High Efficiency	0.22	0.48

Filter type	P/N	#Filters in pack
Aluminum	612266	2
MERV 8	607039	1
High Efficiency	612265	2

Note: This model requires a total of 6 filters. Make sure to get enough packs to meet the required amount.

Dimensions

FRONT VIEW

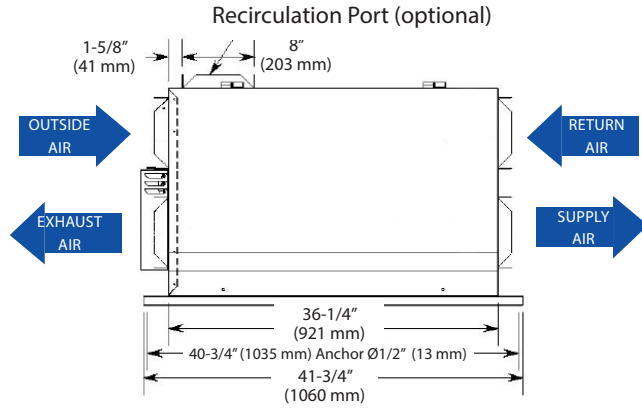

SIDE VIEW

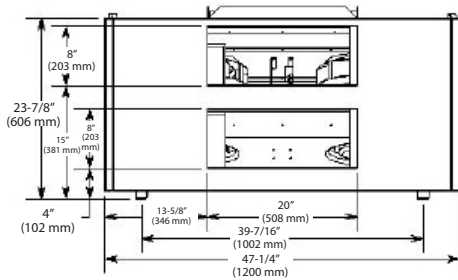

BOTTOM VIEW

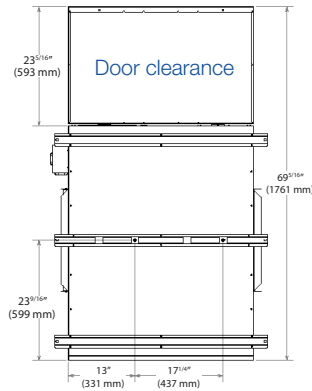

Controls

0-10 VDC inputs (for supply and exhaust) or multiple fixed speed options

Low-voltage dry contact (24 VAC, 20 VA) for:

- Occupancy Control (On/Off)
- Interlock contacts
- Optional Recirculation Mode

24 VAC, 10 VA output for supply and exhaust dampers (by others)

Compatible with :

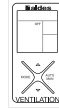

Digital Multifunction Control (P/N 611242-FC)

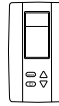

LCD Electronic Multifunction Control (P/N 611227)



20/40/60 Minute Timer (P/N 611228)



Speed Control (Low/Intermittent/High) (P/N 611229)



Mode Control (exchange or recirculation) (P/N 611230)

BACnet™ interface (P/N 611235)

Performance

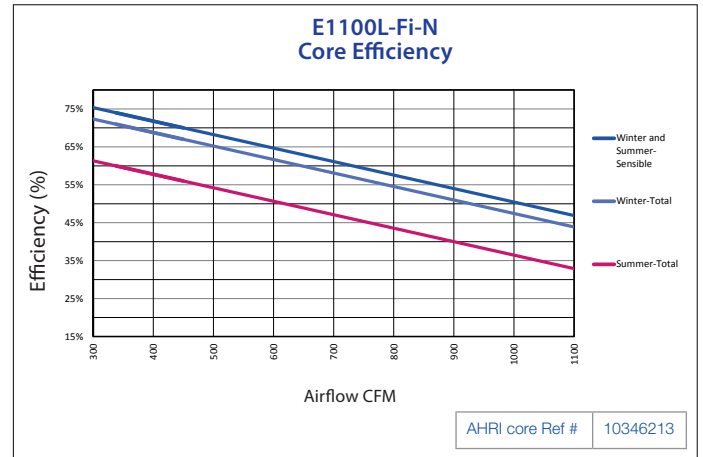
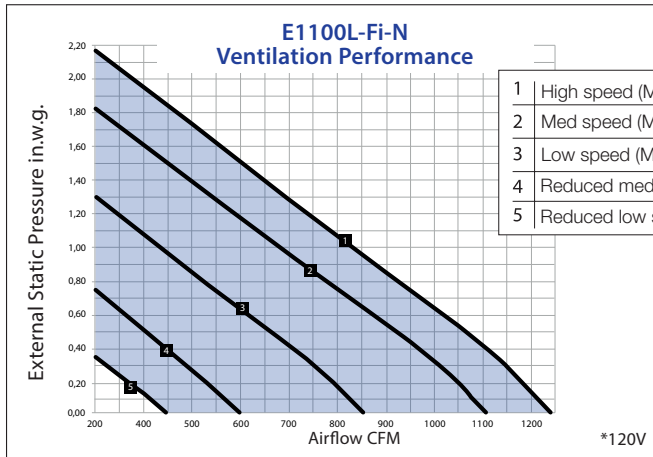

Project:		Architect:	
Location:		Engineer:	
Model #:		Contractor:	
Quantity:		Comments:	
Submitted By:			
Date:			

For more information, contact your Aldes sales advisor, visit aldes-na.com, call 1.800.255.7749, or find us on

