

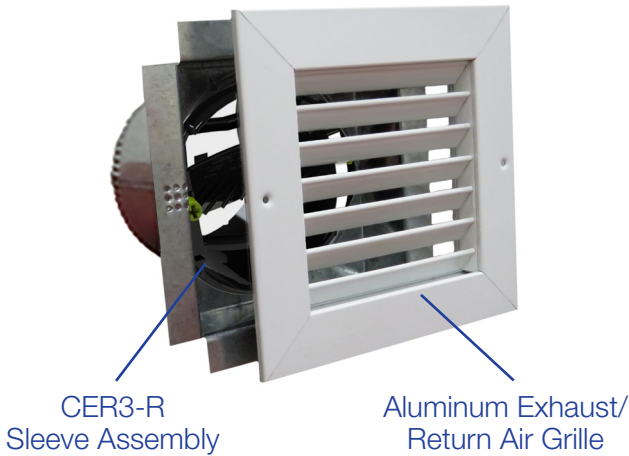

# CER3-R

## CONSTANT EXHAUST REGULATOR

### AIRFLOW & ZONE CONTROL



Made in  
USA

WARRANTY  
7 YEARS

Patent  
pending

## Product Description

The Aldes CER3-R Constant Exhaust Register incorporates a pressure independent balancing damper that automatically regulates airflow in duct systems to constant levels. The passive control element in the CER3-R requires no electric or pneumatic power or sensors, and works solely off system pressure.

The CER3-R compensates for changes in duct pressure caused by stack effect, operable windows and doors, wind, loading filters, etc. The CER3-R provides a low-cost solution to maintaining the correct airflow balance of ventilation systems, improving system performance and indoor air quality, which can provide significant savings on annual operating costs.

## Key Features

- Dual-side airflow adjustment dial and CFM indicator allows you to set or change the airflow quickly without removing the grille.
- CAR3 is enhanced with antimicrobial, anti-static, and flame retardant additives for increased safety and durability.
- Painted grille constructed from heavy gauge extruded aluminum to prevent rusting in humid environments.

## Construction

- CAR3 constructed of amorphous thermoplastic resin enhanced with antimicrobial, anti-static, and flame retardant additives to improve material performance, reduce need for maintenance, and increase safety.
- CAR3 is UL 2043 safety classified and labeled for flame and smoke generation (File No. R39897).
- Galvanized steel sleeve assembly with round duct collar.
- Extruded aluminum exhaust grille; blades fixed at 38°.

## Maintenance

The CER3-R needs no maintenance when used in normal conditions. The addition of antimicrobial and anti-static additives in the material increases the longevity and reliability of the CAR3. There is no risk of dust deposit or obstruction because the CAR3 has no airways subject to clogging. If the intended application includes air heavily loaded with dust or grease, access to the CAR3 is possible through the terminal removable grille.

## Warranty

Guaranteed for 7 years, from date of shipment, against all defects in material or workmanship, provided that the material has been installed and used under normal conditions. This warranty is limited to the repair or replacement of the material.

## APPLICATIONS

- Automatic balancing grille assembly for round duct.
- Balance exhaust/return duct in high-rise building.
- Balance exhaust/return to common areas & living spaces.

# How to Specify Aldes: CER3-R

**Step 1:** Reference the model code below and performance details within this specifications sheet to select the appropriate CER3-R.

**Step 2:** Select the desired **AIRFLOW RANGE**.

**NOTE:** Ranges available: 4, 5, 6, 8 or 10.

See *Airflow Settings and Performance Data* for additional details. Factory calibration of the CAR3 is available on request.

**Step 3:** Select the **ROUND DUCT SIZE**.

**NOTE:** This number cannot be less than the **AIRFLOW RANGE**; i.e. an airflow range of 5 requires a duct size of 5 or more, R5 or R6 respectively.

**Step 4:** Select the **NOMINAL GRILLE WIDTH** and **NOMINAL GRILLE HEIGHT**.

**NOTE:** Nominal width and height must be greater than the duct size; 4, 5, 6, 8 or 10 selected in **ROUND DUCT SIZE**.

*Optional Finishes: anodized or black. Contact Aldes representatives for additional colors.*

## Model Code Example

**CER3-L4-R4-0606**

**PARENT MODEL**

Constant Exhaust Register

**PRESSURE RANGE**

L: Low Pressure (0.12-1.2 in. w.g.)

**AIRFLOW RANGE**

Low-Pressure

- 4: 15-85 CFM (25-144 m<sup>3</sup>/h)
- 5: 35-180 CFM (59-306 m<sup>3</sup>/h)
- 6: 45-260 CFM (76-442 m<sup>3</sup>/h)
- 8: 70-385 CFM (119-655 m<sup>3</sup>/h)
- 10: 110-620 CFM (187-1053 m<sup>3</sup>/h)

**ROUND DUCT SIZE**

- R4: 4 inch
- R5: 5 inch
- R6: 6 inch
- R8: 8 inch
- R10: 10 inch

**NOMINAL GRILLE WIDTH**

**NOMINAL GRILLE HEIGHT**

## CER3-R Dimensions

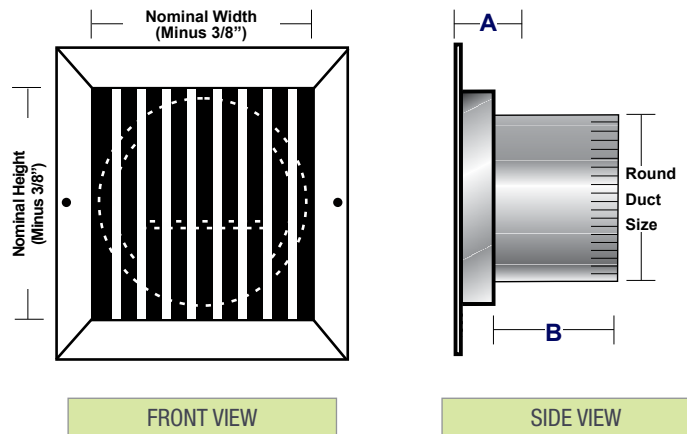

ROUND DUCT SIZE	REGISTER DEPTH (A)	COLLAR LENGTH (B)	TOTAL DEPTH
4"	2.0"	4.5"	6.5"
5"	2.25"	5.5"	7.75"
6"	2.5"	5.5"	8.0"
8"	3.0"	8.0"	11.0"
10"	3.5"	9.5"	13.0"

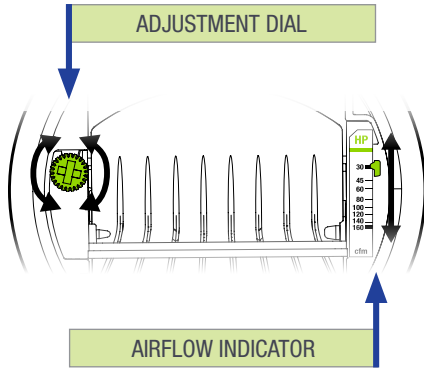

## Airflow Settings & Performance Data

Airflow rate can be set or adjusted by rotating the dial from either side. The airflow indicator will move to show the selected CFM. The airflow label has multiple defined setpoints, but the unique adjustment mechanism of the CAR3 allows for infinite adjustability between the minimum and maximum limits.

Performance charts found in the specifications sheet reflect this data, with the available range (shaded) and marked setpoints (lines). The CAR3 will maintain the airflow accurately to within +/- 10% of the indicated lines below for each marked setpoint. At the higher airflow rates, the minimum pressure required to achieve the selected airflow may exceed 0.12 in. w.g.

### CAR3 4" DIAMETER (100 mm)

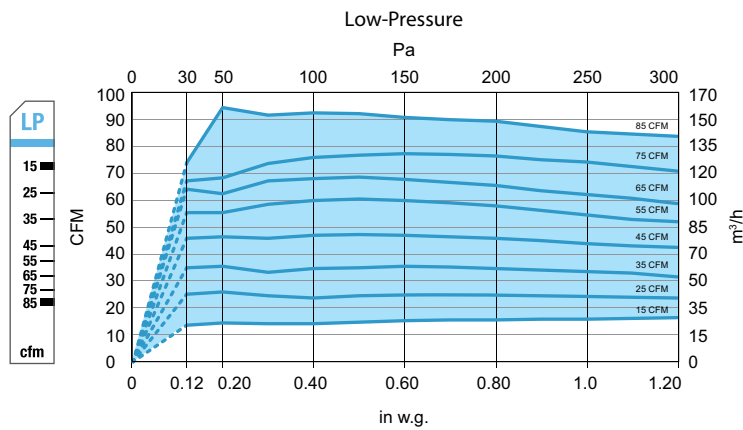

### CAR3 5" DIAMETER (125 mm)

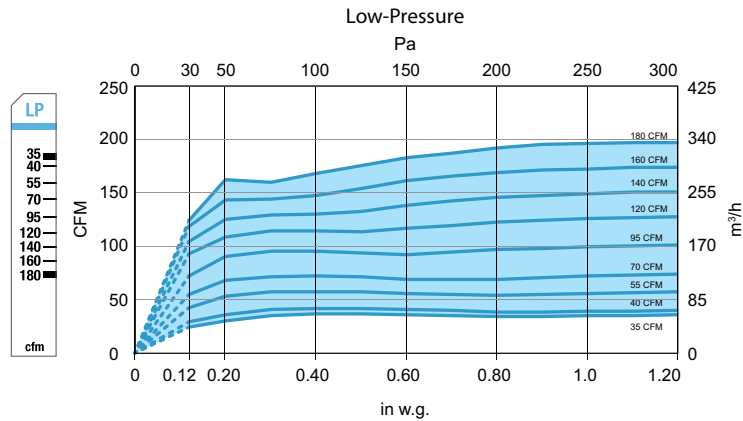

### CAR3 6" DIAMETER (150 mm)

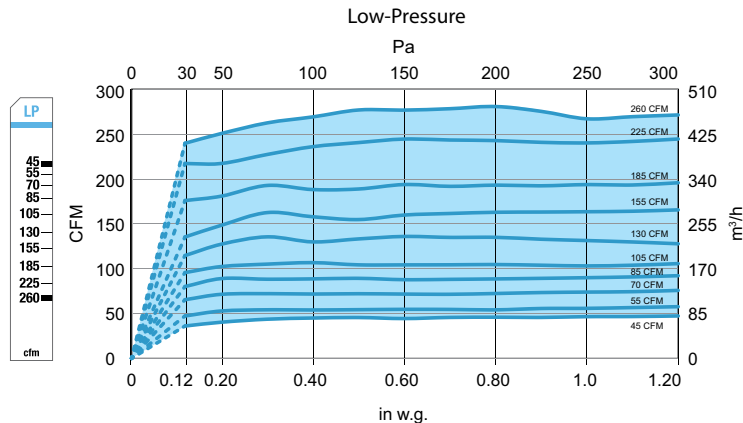

Airflow measurements taken at 68°F (20°C) at 1 atmosphere pressure.

**CAR3 8" DIAMETER (200 mm)**

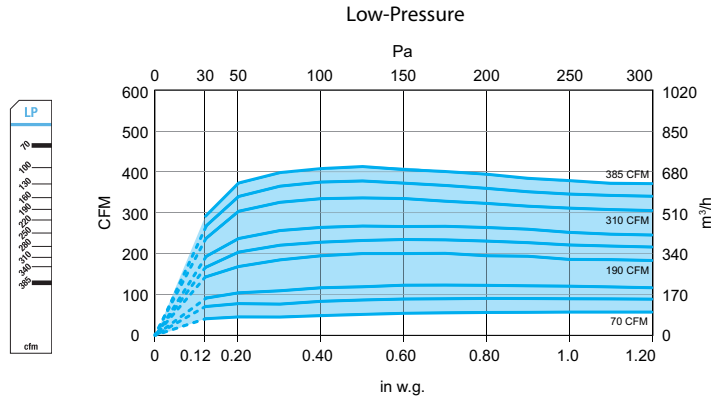

**CAR3 10" DIAMETER (250 mm)**

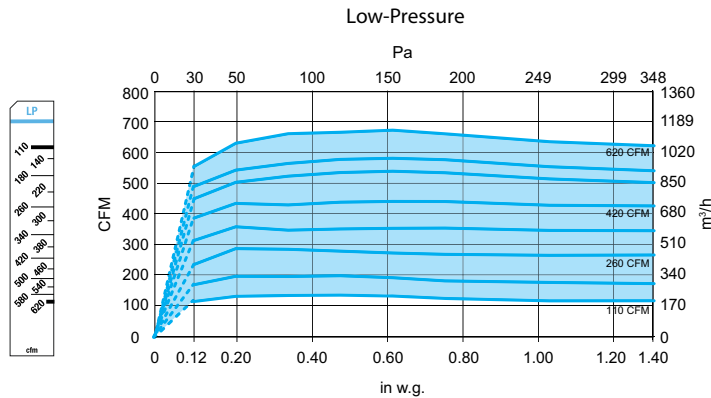

Airflow measurements taken at 68°F (20°C) at 1 atmosphere pressure.

## Recommended Specification

Model CER3-R Constant Exhaust Register by ALDES North America shall be capable of maintaining constant airflow within +/-10% of the scheduled flow rate, within the operating range of 0.12 to 1.2 in. w.g. differential pressure for low-pressure model (CAR3-L). CER3-R solely operate on duct pressure and require no external power supply or sensor, and shall be rated for use in air temperatures ranging from -25°F to 140°F (-32°C to 60°C). CER3-R shall be provided as an assembly consisting of a CAR3, painted aluminum grille, and galvanized steel sleeve assembly with duct collar to attach round duct. Each airflow regulator shall be adjustable without removing the grille. Each CER3-R must be calibrated to match the airflow indicated on the schedule or drawing. Regulator must be classified per UL 2043 and carry the UL mark indicating compliance. Constant Airflow Regulator is enhanced with antimicrobial, anti-static, and flame retardant additives for increased durability and safety, and covered under warranty for a period of no less than seven years. Constant Airflow Regulator shall be installed in accordance with local code and manufacturer's instructions.

For more information, contact your Aldes sales advisor, visit [aldes-na.com](http://aldes-na.com), call 1.800.255.7749, or find us on

