

Intertek
C22.2 no113
UL 1812

LIGHT COMMERCIAL SERIES

HRV

H1100-Fi-N, H1100A-Fi-N & H1100-Fi-P-N

Heat Recovery Ventilator
1245 CFM at 0.4 in.w.g (ESP)



Plate Exchanger
Material: Polypropylene or aluminum

Casing
Material: Painted galvanized steel 22GA
Insulation: 1"(25 mm) Fiberglass with FSK
Drain Connection: Ø 1/2" (Ø 13 mm)
Duct Connections: 20" x 8" (508mm x 203mm)
Width: 36-1/4" (921mm)
Height: 23-7/8" (606mm)
Depth: 47-1/4" (1200mm)

Polypropylene core
Unit Weight: 206 lb (93 kg); 216 lb (98 kg) with recirculation
Shipping Weight: 261 lb (118 kg); 271 lb (193 kg) with recirculation
Aluminum core
Unit Weight: 223 lb (101 kg); 233 lb (106 kg) with recirculation
Shipping Weight: 278 lb (126 kg); 288 lb (131 kg) with recirculation



Mounting
Supplied with base rails. Support rods not included.



Electrical Requirements
120V/1p/60 Hz: FLA 8.2A, MCA 8.7A, MOP 15A
Terminal block for direct wiring to the building's electrical system.
Fused disconnect not included.



Frost Control
Cycles controlled by a temperature sensor when outdoor temperatures fall below 23°F (-5°C).
• Standard: Exhaust Defrost
• Optional: Recirculation Defrost (P/N 683950)



Blowers
Four backward-inclined motorized impeller, direct-drive PSC, variable speed, external rotor



Filters
Type : Aluminum (P/N 683951)
Optional : MERV 8 (P/N 683952), Charcoal (P/N 683953), or High Efficiency/MERV13 Equivalent (P/N 683954)

PRODUCT DESCRIPTION

The H1100-Fi-N (polypropylene core) and H1100A-Fi-N (aluminum core) heat recovery ventilators provide up to 1245 cubic feet per minute (585 L/s) of fresh outdoor air while exhausting an equivalent amount of stale indoor air, creating a well-balanced ventilation system. The H1100-Fi-P-N is a specialty model for indoor pools and other high-humidity applications, with a stainless steel interior, foam filters and anti-corrosion sealant.

These ventilators are recommended for midsized non-residential spaces or dedicated zones within larger buildings such as classrooms, common areas of residential complexes, pools and indoor parking garages.

Designed for versatile indoor installation, Aldes light commercial ventilators can fit almost anywhere and still provide easy access to the internal components for quick maintenance. The units also offer a choice of five continuous operation speeds and a demand-controlled high speed exchange mode.

KEY FEATURES

- Electronically and independently adjustable supply and exhaust blowers (FlexControl).
- Painted, heavy-gauge galvanized steel cabinets are attractive, rust-resistant and extremely durable.
- Doors on both sides of the unit to allow easy access to filters, cores and motors, no matter the installation constraints
- Fan exhaust frost protection, or optional recirculation defrost kit (factory installed or upgraded in the field).
- Four efficient, totally enclosed motors with backward inclined impellers.
- Units with polypropylene cores can be used for indoor pools and spas. The H1100-Fi-P has a stainless steel interior, foam filters and anti-corrosion sealant for high-humidity environments.

Additional Air Pressure Drop with Optional Filters		
Filter Type	Airflow CFM (L/S)	
		500 (236)
MERV 8	0.04	0.15
Charcoal	0.04	0.15
High Efficiency	0.22	0.48

Dimensions

FRONT VIEW

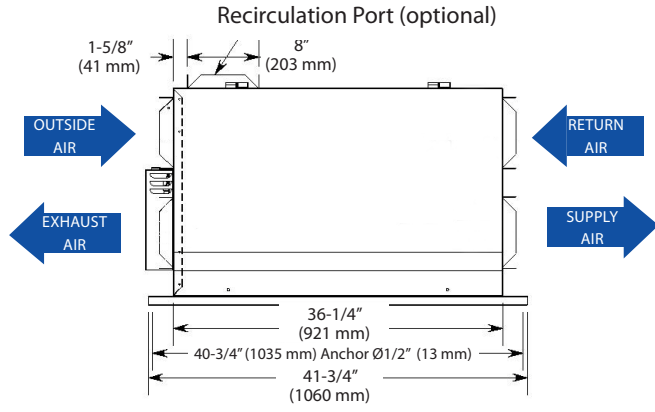

SIDE VIEW

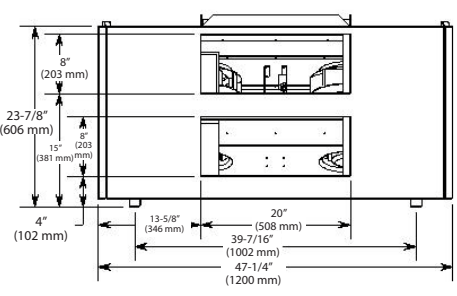

BOTTOM VIEW

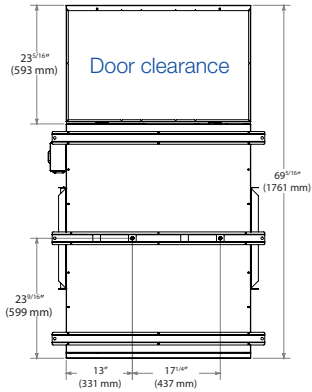

Controls

0-10 VDC inputs (for supply and exhaust) or multiple fixed speed options

Low-voltage dry contact (24 VAC, 20 VA) for:

- Occupancy Control (On/Off)
- Interlock contacts
- Optional Recirculation Mode

24 VAC, 10 VA output for supply and exhaust dampers (by others)

Compatible with :

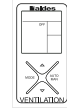

Digital Multifunction Control (P/N 611242-FC)

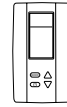

LCD Electronic Multifunction Control (P/N 611227)



20/40/60 Minute Timer (P/N 611228)



Speed Control (Low/Intermittent/High) (P/N 611229)



Mode Control (exchange or recirculation) (P/N 611230)

BACnet™ interface (P/N 611235)

Performance

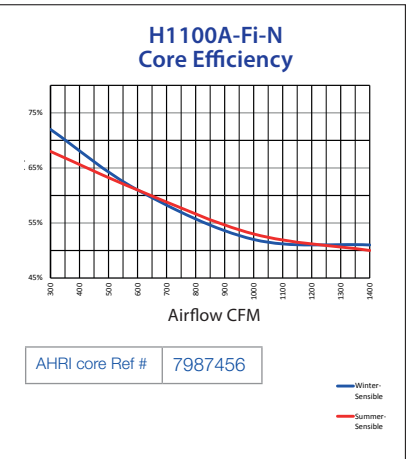
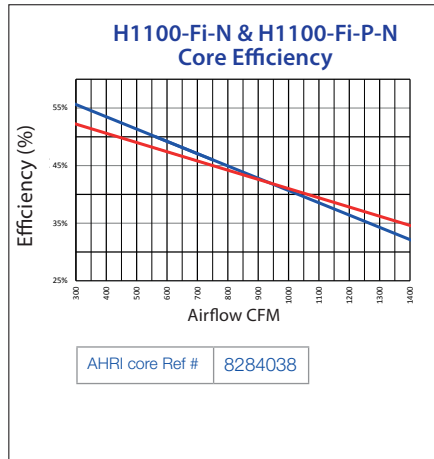
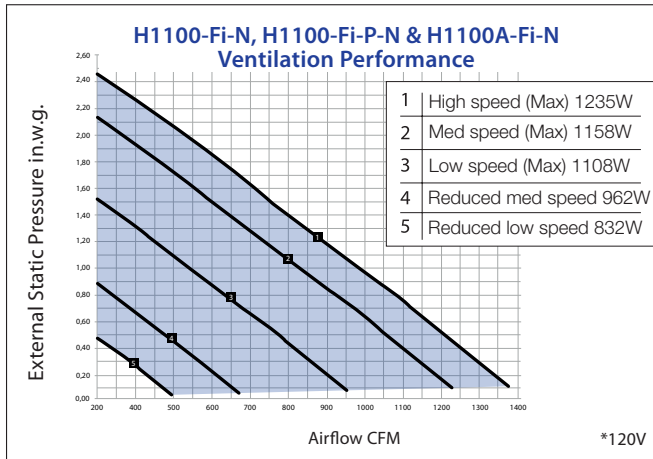

Project:		Architect:	
Location:		Engineer:	
Model #:		Contractor:	
Quantity:		Comments:	
Submitted By:			
Date:			

For more information, contact your Aldes sales advisor, visit aldes-na.com, call 1.800.255.7749, or find us on

