



# STANDARD COMMERCIAL SE2000i Energy Recovery Ventilator

PRODUCT  
SPECIFICATIONS  
& TECHNICAL  
DATA



**NOMINAL CAPACITY**  
1000-2000 CFM

### CASING – STANDARD

- Double-wall cabinet
- 22-gauge galvanized steel interior and exterior
- Access doors with quarter-turn handles
- 22-gauge galvanized steel drain pan
- Drain Connections: 1" NPT
- Insulation: 1" (25 mm)

### CASING – OPTIONAL

- Painted white baked enamel outside finish
- Pool Construction: TEFC motors, stainless steel interior, and epoxy-coated fans (NOTE: ERV not recommended for indoor pool applications)
- Removable access panels

### MOUNTING – STANDARD

On platform

### PLATE EXCHANGER OPTIONS

Standard Enthalpy (sensible and latent heat transfer)

Quantity: 2  
Pitch: 0.14" (3.5 mm)  
Dimensions: 21-7/32" x 21-7/32" x 19-3/8"  
(539 mm x 539 mm x 492 mm)



High-Efficiency Enthalpy (sensible and latent heat transfer)

Quantity: 2  
Pitch: 0.10" (2.5 mm)  
Dimensions: 21-7/32" x 21-7/32" x 19-3/8"  
(539 mm x 539 mm x 492 mm)



High-Latent-Transfer Enthalpy (sensible and latent heat transfer)

Quantity: 2  
Pitch: 0.10" (2.5 mm)  
Dimensions: 21-7/32" x 21-7/32" x 19-3/8"  
(539 mm x 539 mm x 492 mm)



### BLOWERS & MOTORS – STANDARD OPTIONS

Blowers:

- Quantity: 2
- Forward-curved
- Permanently sealed and lubricated ball bearings
- Power transmission by adjustable pulleys and belts

Motors:

- Type: Inverter duty 10:1
- Maximum Power: 3 hp
- Available Voltage:
  - » 120, 208, 230 V / 1ph / 60Hz
  - » 208, 230, 460, 575 V / 3ph / 60Hz

(See table on page 2 for details)

### EC MOTORS – OPTIONAL

Blowers:

- Quantity: 2 (1 per air stream)
- Plenum Type: Backward Inclined
- Permanently sealed and lubricated ball bearings
- Direct Drive

EC Motors:

- Maximum Power:
  - » 1.9 kW at 208-230 V / 3ph / 60Hz
  - » 2.5 kW at 460 V / 3ph / 60Hz
- Available Voltage:
  - » 208, 230, 460 V / 3ph / 60Hz

(See table on page 2 for details)

### ELECTRICAL & CONTROLS – STANDARD

- 24 V double motor contactor with start-stop dry contact
- Non-fused disconnect (NEMA 4)
- 24 V transformer for controls

### ELECTRICAL & CONTROLS – OPTIONAL

- Fused disconnect
- 24 VAC, 20 VA power available for accessories

### FILTERS – STANDARD

Quantity: 2 supply, 2 exhaust

Type: MERV 8

Dimensions: 18" x 20" x 2" (457 mm x 508 mm x 51 mm)

### FILTERS – OPTIONAL

MERV 13 Filters (substitute on supply air circuit only)

### LISTED BY



# SE2000i Features (Continued)

## FROST PREVENTION/CONTROL – OPTIONS

If no defrost mode is selected, it is the customer's responsibility to protect the core from freezing.

Frost control activated by a temperature reference: 14°F (-10°C)

Internal Pre-Heat by Electric Coil:

- Powered by unit, SCR control (unavailable with 120 V)

Internal Pre-Heat by Hot Water Coil:

- 0-10 V signal on the control panel
- Piping connections under unit

Exhaust Defrost:

- Supply air blower shuts down and outside air damper closes. Warm exhaust air defrosts the core until it is completely defrosted.
- Includes motorized and insulated damper on fresh air intake (OA)

Recirculation Defrost:

- Exhaust air blower shuts down, outside air damper closes, exhaust air damper (optional) closes, and recirculation damper (included) opens. Exhaust air warms up the core for a predetermined amount of time (see table at right).
- Includes motorized and insulated damper on fresh air intake (OA)

## POST-HEAT COILS

Post-Heat by Electric Coil:

- Powered by unit, SCR control (unavailable with 120 V)

Post-Heat by Hot Water Coil:

- 0-10VDC signal to maintain supply air temperature, or 0-10VDC signal by others

## OPTIONAL COMPONENTS

- Motorized and insulated damper for exhaust port (EA)
  - » Adds 7" (178 mm) to overall unit width
- Non-insulated backdraft damper for exhaust port (EA)
- Motorized and insulated damper on fresh air intake (OA) (included with exhaust defrost and recirculation)

## WARRANTY

Core Assembly:

- Standard & High-Efficiency Enthalpy: Limited 10-year
- High-Latent-Transfer: Limited 2-year

All Other Covered Components: Limited 2-year

RECIRCULATION DEFROST CYCLE TEMPERATURE			
Outside Temperature (T)		Minutes Defrost/Vent	
°F	°C	Standard	Extended
T > 14	T > -10	N/A	N/A
14 > T > -13	-10 > T > -25	7/25	10/20
-13 > T	-25 > T	10/22	10/15

# SE2000i Motor & Blower Options\*

		PARAMETERS																			
		HP					VOLTAGE & PHASE								MOTOR SPEED						
		3/4	1	1.5	2	3	1-PHASE			3-PHASE					SINGLE SPEED	2-SPEED		VARIABLE SPEED			
							120 V	208 V	230 V	208 V	230 V	460 V	575 V	MOTOR		VFD	MOTOR	VFD			
MOTOR TYPE & EFFICIENCY†	ODP, EPAct	√	√	√	√	■	√	√	√	■	■	■	■	■	■	√	√	√	■	■	√
	ODP, Premium	■	■	■	■	√	■	■	■	■	■	■	■	■	■	√	■	√	■	■	√
	TEFC, EPAct	√	√	■	■	■	√	√	√	■	■	■	■	■	■	√	■	√	■	■	√
	TEFC, Premium	■	■	√	√	√	■	■	■	■	■	■	■	■	■	√	■	√	■	■	√
	EC Motors	N/A					■	■	■	■	■	■	■	■	√	√	■	■	■	√	

\*See pages 8-9 for motor sizing. See page 9 for EC Motors Power Consumption.

†Premium efficiency required when available.

# SE2000i Dimensions

Keep a minimum distance of 42" (1067 mm) in front of the unit and 24" (610 mm) behind it

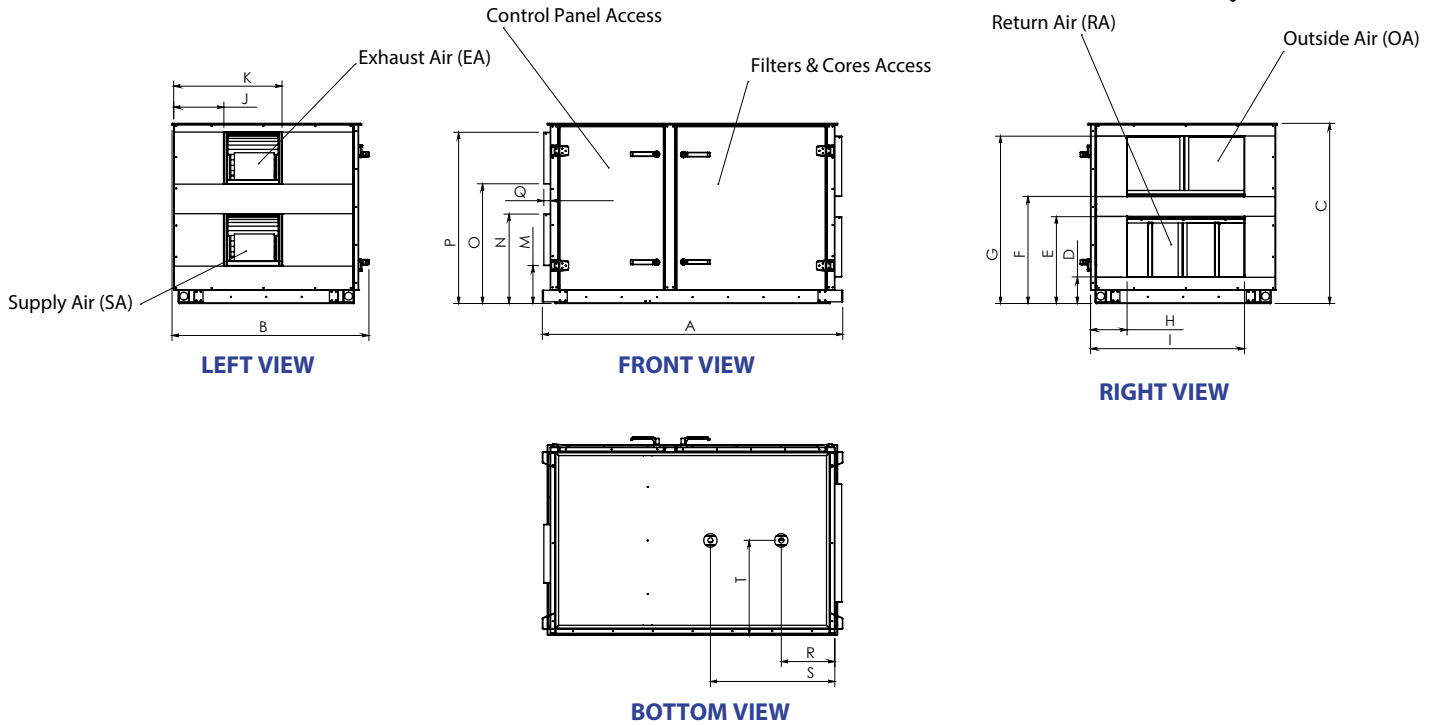
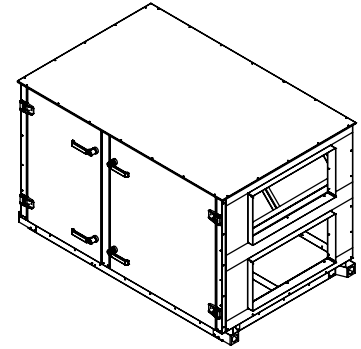
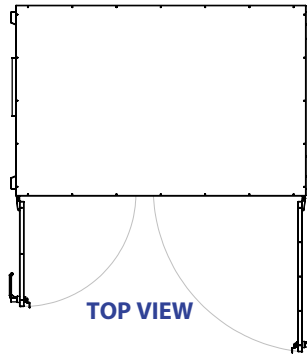

DIMENSIONS in inches (mm)										
Overall				Openings						
A*			B	C	D	E	F	G	H	
Standard	1 Extension	2 Extensions								
66 (1676)	86 (2184)	106 (2692)	46 (1168)	46.75 (1187)	7.75 (197)	21.25 (540)	27.75 (705)	41.25 (1048)	8.25 (210)	
Openings										
I	J	K	M	N	O	P	Q	R	S	T
34.75 (883)	11.375 (289)	24.5 (622)	8.5 (216)	20 (508)	27.75 (705)	39.25 (997)	1.5 (38)	12.125 (308)	28.125 (714)	21 (533)

\*Optional motorized and insulated damper for exhaust port (EA) adds 7" (178 mm) to overall unit width

# SE2000i Configurations & Weights

AVAILABLE CONFIGURATIONS*
1-2-5-6
1-3-5-6
1-2-4-6
1-3-4-6

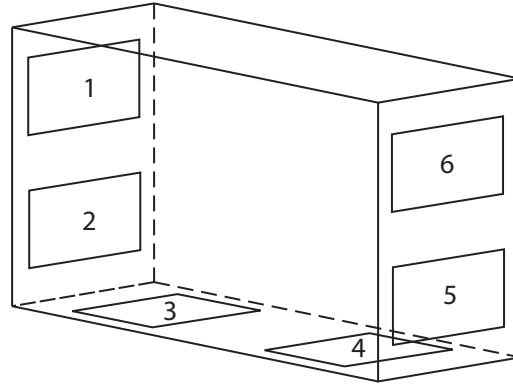

DUCT CONNECTION KEY	
1	Exhaust Air (EA)
2, 3	Supply Air (SA)
4, 5	Return Air (RA)
6	Outside Air (OA)

\*Mirror Image Cabinet Also Available

SE2000i WEIGHTS & DIMENSIONS †	
Minimum Unit Weight	625 lbs (283 kg)
Maximum Unit Weight	1260 lbs (572 kg)
Minimum Shipping Weight	670 lbs (304 kg)
Maximum Shipping Weight	1305 lbs (592 kg)

† Actual weight may vary by ±10%.

# Standard Enthalpy Core Performance

AHRI STANDARD CONDITIONS	CONDITIONS	
Outside Air Temperature	Winter	Summer
Dry Bulb	35°F (1.7°C)	95°F (35°C)
Wet Bulb	33°F (0.6°C)	78°F (25.6°C)
Exhaust Air Temperature	Winter	Summer
Dry Bulb	70°F (21.1°C)	75°F (23.9°C)
Wet Bulb	58°F (14.4°C)	63°F (17.2°C)

Note: Efficiencies are based on AHRI standard winter conditions.

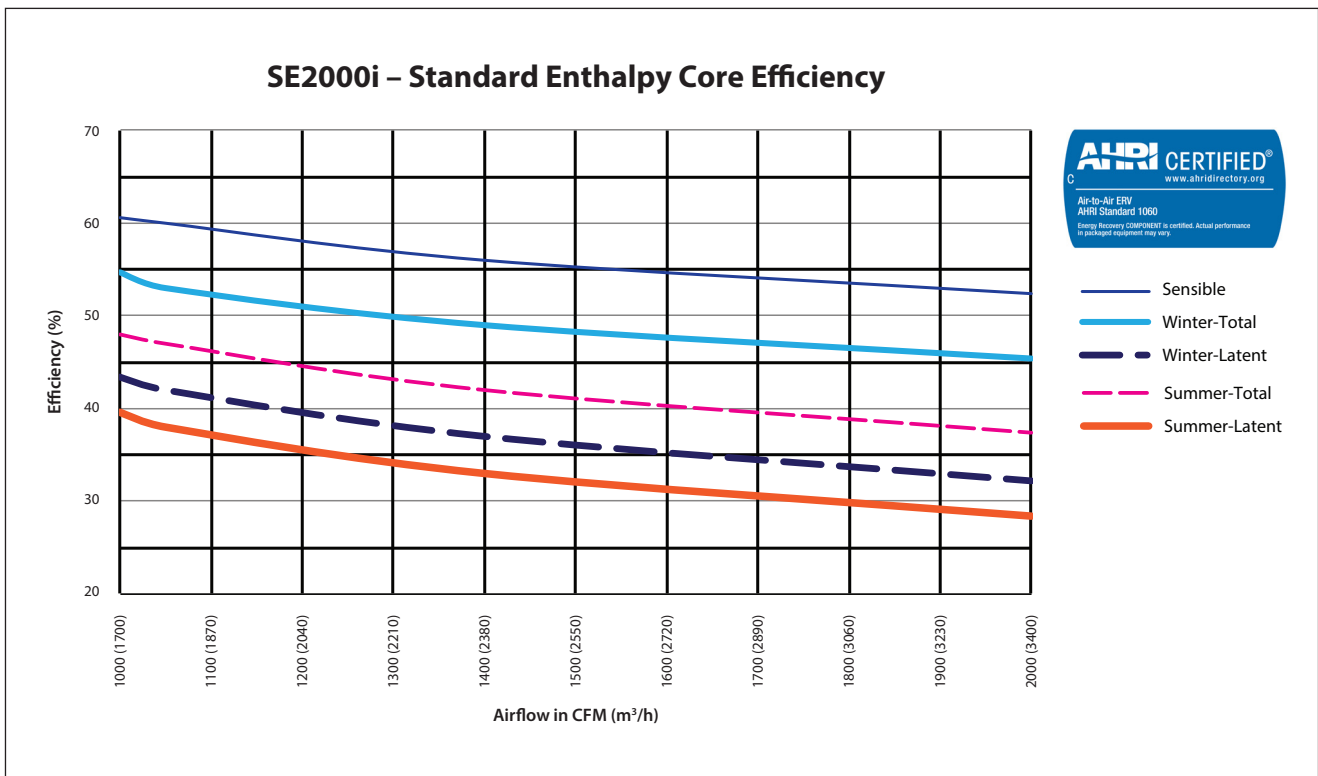

# High-Efficiency Enthalpy Core Performance

AHRI STANDARD CONDITIONS	CONDITIONS	
Outside Air Temperature	Winter	Summer
Dry Bulb	35°F (1.7°C)	95°F (35°C)
Wet Bulb	33°F (0.6°C)	78°F (25.6°C)
Exhaust Air Temperature	Winter	Summer
Dry Bulb	70°F (21.1°C)	75°F (23.9°C)
Wet Bulb	58°F (14.4°C)	63°F (17.2°C)

Note: Efficiencies are based on AHRI standard winter conditions.

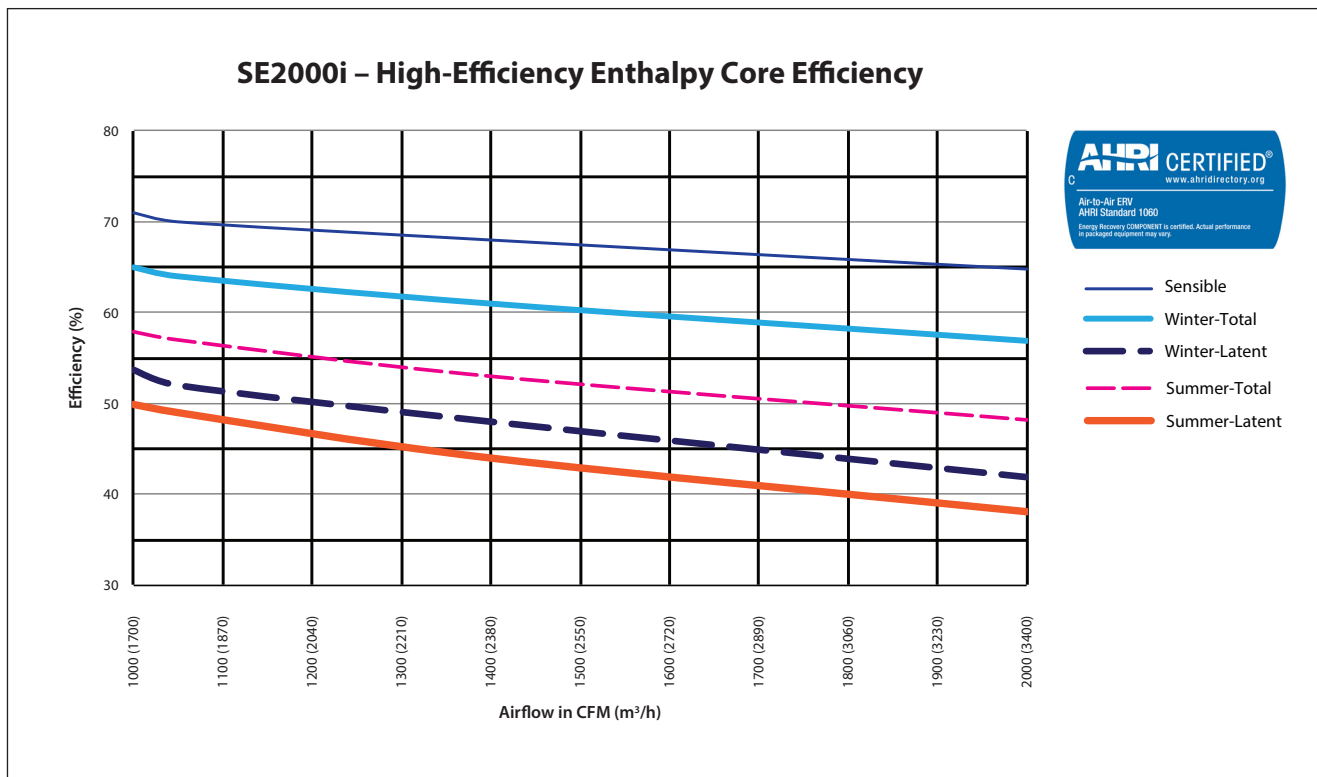

# High-Latent-Transfer Enthalpy Core Performance

AHRI STANDARD CONDITIONS	CONDITIONS	
Outside Air Temperature	Winter	Summer
Dry Bulb	35°F (1.7°C)	95°F (35°C)
Wet Bulb	33°F (0.6°C)	78°F (25.6°C)
Exhaust Air Temperature	Winter	Summer
Dry Bulb	70°F (21.1°C)	75°F (23.9°C)
Wet Bulb	58°F (14.4°C)	63°F (17.2°C)

Note: Efficiencies are based on AHRI standard winter conditions.

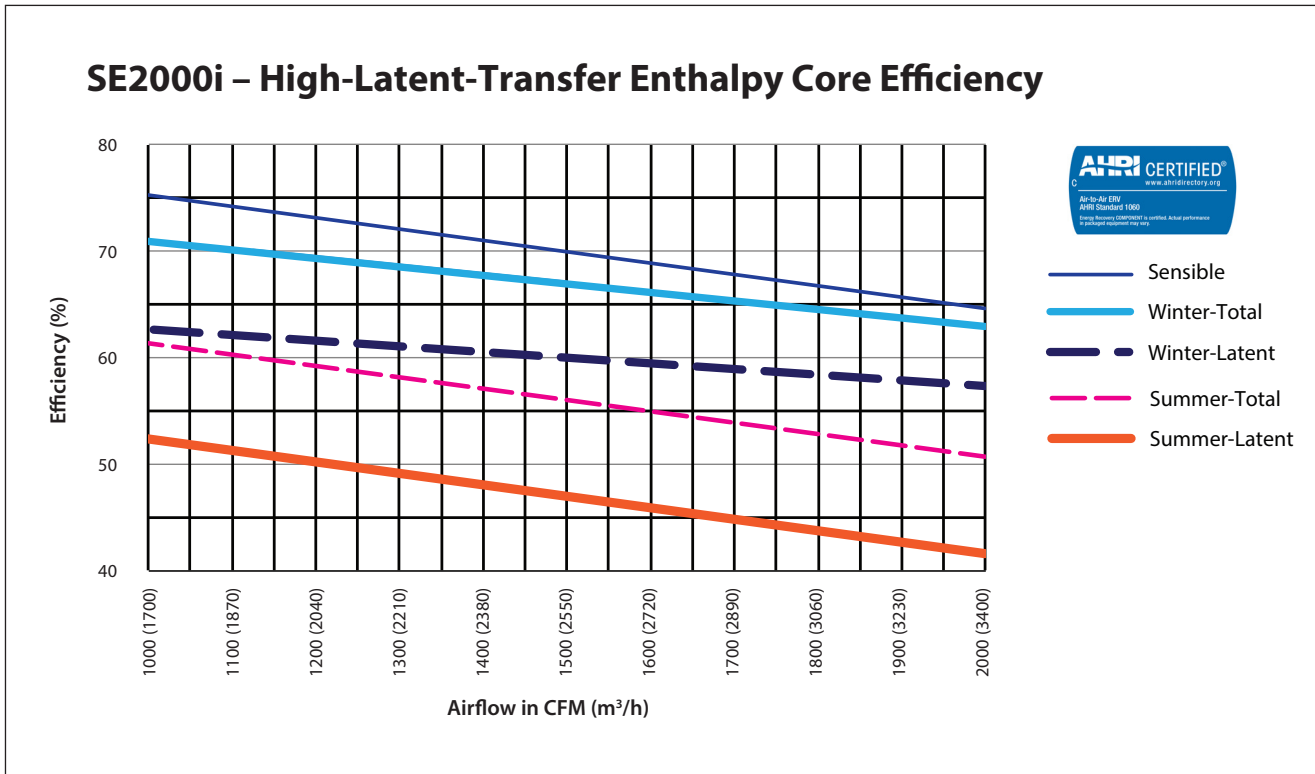

## Motor Selection – Standard Enthalpy Core

SUPPLY/EXHAUST																				
MOTOR	CFM (m <sup>3</sup> /h)	EXTERNAL STATIC PRESSURE (inH <sub>2</sub> O) - SUPPLY/EXHAUST																		MOTOR
		0.25 (60 Pa)			0.50 (125 Pa)			0.75 (185 Pa)			1.00 (250 Pa)			1.25 (310 Pa)			1.50 (375 Pa)			
		RPM	BHP	HP	RPM	BHP	HP	RPM	BHP	HP	RPM	BHP	HP	RPM	BHP	HP	RPM	BHP	HP	
3/4 hp	1000 (1700)	903	0.23	0.28	1067	0.32	0.38	1210	0.42	0.50	1336	0.52	0.62	1448	0.62	0.74	1549	0.73	0.88	1 hp
	1100 (1870)	923	0.26	0.31	1083	0.36	0.43	1224	0.46	0.55	1349	0.57	0.68	1463	0.68	0.82	1567	0.80	0.96	
	1200 (2040)	950	0.31	0.37	1102	0.41	0.49	1241	0.52	0.62	1366	0.63	0.76	1479	0.75	0.90	1583	0.87	1.04	1.5 hp
	1300 (2210)	971	0.35	0.42	1117	0.46	0.55	1253	0.57	0.68	1376	0.69	0.83	1490	0.81	0.97	1594	0.94	1.13	
	1400 (2380)	999	0.41	0.49	1138	0.51	0.61	1268	0.63	0.76	1390	0.75	0.90	1503	0.88	1.06	1607	1.02	1.22	
	1500 (2550)	1027	0.47	0.56	1160	0.58	0.70	1285	0.70	0.84	1404	0.83	1.00	1515	0.96	1.15	1619	1.10	1.32	
	1600 (2720)	1056	0.54	0.65	1183	0.65	0.78	1303	0.77	0.92	1418	0.90	1.08	1527	1.04	1.25	1630	1.19	1.43	
1700 (2890)	1084	0.62	0.74	1205	0.73	0.88	1321	0.85	1.02	1431	0.98	1.18	1538	1.13	1.36	1640	1.28	1.54		
1 hp	1800 (3060)	1114	0.70	0.84	1229	0.81	0.97	1341	0.94	1.13	1448	1.07	1.28	1550	1.22	1.46	1650	1.37	1.64	2 hp
	1900 (3230)	1143	0.79	0.95	1253	0.90	1.08	1360	1.03	1.24	1464	1.17	1.40	1564	1.32	1.58	1661	1.47	1.76	
1.5 hp	2000 (3400)	1172	0.89	1.07	1278	1.00	1.20	1381	1.13	1.36	1481	1.27	1.52	1578	1.42	1.70	1672	1.58	1.90	

## Motor Selection – High-Efficiency Enthalpy Core

SUPPLY/EXHAUST																				
MOTOR	CFM (m <sup>3</sup> /h)	EXTERNAL STATIC PRESSURE (inH <sub>2</sub> O) - SUPPLY/EXHAUST																		MOTOR
		0.25 (60 Pa)			0.50 (125 Pa)			0.75 (185 Pa)			1.00 (250 Pa)			1.25 (310 Pa)			1.50 (375 Pa)			
		RPM	BHP	HP	RPM	BHP	HP	RPM	BHP	HP	RPM	BHP	HP	RPM	BHP	HP	RPM	BHP	HP	
3/4 hp	1000 (1700)	1036	0.30	0.36	1183	0.40	0.48	1311	0.50	0.60	1426	0.60	0.72	1530	0.71	0.85	1622	0.81	0.97	1 hp
	1100 (1870)	1064	0.35	0.42	1208	0.45	0.54	1335	0.56	0.67	1450	0.67	0.80	1555	0.78	0.94	1652	0.90	1.08	
	1200 (2040)	1085	0.40	0.48	1225	0.50	0.60	1351	0.62	0.74	1466	0.73	0.88	1571	0.86	1.03	1669	0.98	1.18	1.5 hp
	1300 (2210)	1112	0.45	0.54	1247	0.56	0.67	1372	0.68	0.82	1485	0.81	0.97	1590	0.94	1.13	1687	1.07	1.28	
	1400 (2380)	1138	0.51	0.61	1268	0.63	0.76	1390	0.75	0.90	1503	0.88	1.06	1607	1.02	1.22	1705	1.16	1.39	
	1500 (2550)	1165	0.58	0.70	1290	0.70	0.84	1409	0.83	1.00	1520	0.97	1.16	1623	1.11	1.33	1720	1.25	1.50	
1 hp	1600 (2720)	1192	0.66	0.79	1312	0.78	0.94	1427	0.91	1.09	1536	1.05	1.26	1638	1.20	1.44	1734	1.35	1.62	2 hp
	1700 (2890)	1224	0.75	0.90	1339	0.87	1.04	1449	1.01	1.21	1555	1.15	1.38	1656	1.30	1.56	1751	1.46	1.75	
1.5 hp	1800 (3060)	1256	0.84	1.01	1366	0.97	1.16	1472	1.11	1.33	1575	1.25	1.50	1674	1.41	1.69	1768	1.57	1.88	3 hp
	1900 (3230)	1288	0.94	1.13	1394	1.07	1.28	1497	1.22	1.46	1595	1.37	1.64	1691	1.52	1.82	1784	1.69	2.03	
	2000 (3400)	1319	1.05	1.26	1421	1.19	1.43	1520	1.33	1.60	1616	1.48	1.78	1709	1.65	1.98	1799	1.81	2.17	
2100 (3570)	1351	1.18	1.42	1449	1.31	1.57	1545	1.46	1.80	1637	1.61	1.93	1727	1.78	2.14	1815	1.95	2.34		
2 hp	2200 (3740)	1387	1.31	1.57	1480	1.45	1.74	1573	1.73	2.10	1663	1.76	2.11	1751	1.92	2.30	1836	2.10	2.52	
	2250 (3825)	1405	1.38	1.66	1497	1.52	1.82	1587	1.67	2.00	1676	1.83	2.20	1762	2.00	2.40	1846	2.17	2.60	

### NOTES:

hp = bhp x 1.2

Internal static pressure will vary based on selected options.

Motor selections do not apply to EC Motors.



# Motor Selection – High-Latent-Transfer Enthalpy Core

SUPPLY/EXHAUST																				
MOTOR	CFM (m³/h)	EXTERNAL STATIC PRESSURE (inH <sub>2</sub> O) - SUPPLY/EXHAUST																		MOTOR
		0.25 (60 Pa)			0.50 (125 Pa)			0.75 (185 Pa)			1.00 (250 Pa)			1.25 (310 Pa)			1.50 (375 Pa)			
		RPM	BHP	HP	RPM	BHP	HP	RPM	BHP	HP	RPM	BHP	HP	RPM	BHP	HP	RPM	BHP	HP	
3/4 hp	1000 (1700)	1080	0.33	0.40	1221	0.42	0.50	1345	0.53	0.64	1457	0.63	0.76	1557	0.74	0.89	1647	0.84	1.01	1.5 hp
	1100 (1870)	1112	0.38	0.46	1250	0.48	0.58	1372	0.59	0.71	1484	0.70	0.84	1586	0.82	0.98	1680	0.94	1.13	
	1200 (2040)	1143	0.44	0.53	1278	0.55	0.66	1399	0.66	0.79	1509	0.78	0.94	1611	0.90	1.08	1706	1.03	1.24	
	1300 (2210)	1167	0.50	0.60	1298	0.61	0.73	1418	0.73	0.88	1528	0.86	1.03	1630	0.99	1.19	1725	1.12	1.34	
	1400 (2380)	1197	0.56	0.67	1324	0.68	0.82	1441	0.81	0.97	1550	0.94	1.13	1651	1.08	1.30	1746	1.22	1.46	
1 hp	1500 (2550)	1225	0.64	0.77	1348	0.76	0.91	1463	0.90	1.08	1570	1.03	1.24	1670	1.18	1.42	1764	1.32	1.58	2 hp
	1600 (2720)	1251	0.72	0.86	1368	0.84	1.01	1480	0.98	1.18	1585	1.12	1.34	1685	1.27	1.52	1778	1.42	1.70	
	1700 (2890)	1285	0.81	0.97	1397	0.94	1.13	1505	1.08	1.30	1609	1.23	1.48	1706	1.38	1.66	1799	1.54	1.85	
1.5 hp	1800 (3060)	1309	0.90	1.08	1418	1.03	1.24	1522	1.18	1.42	1623	1.33	1.60	1719	1.48	1.78	1811	1.65	1.98	3 hp
	1900 (3230)	1339	1.00	1.20	1444	1.14	1.37	1544	1.29	1.55	1641	1.44	1.73	1736	1.60	1.92	1827	1.77	2.12	
	2000 (3400)	1368	1.12	1.34	1469	1.26	1.51	1567	1.40	1.68	1661	1.56	1.87	1753	1.73	2.08	1842	1.90	2.28	
	2100 (3570)	1394	1.23	1.48	1492	1.37	1.64	1586	1.53	1.80	1678	1.68	2.02	1766	1.85	2.22	1854	2.03	2.44	
2 hp	2200 (3740)	1428	1.37	1.64	1521	1.51	1.81	1613	1.67	2.00	1702	1.83	2.20	1788	2.00	2.40	1873	2.17	2.60	
	2250 (3825)	1442	1.44	1.73	1533	1.58	1.90	1623	1.73	2.10	1711	1.90	2.28	1796	2.07	2.48	1879	2.25	2.70	

**NOTES:**

hp = bhp x 1.2

Internal static pressure will vary based on selected options.

Motor selections do not apply to EC Motors.

## EC Motors

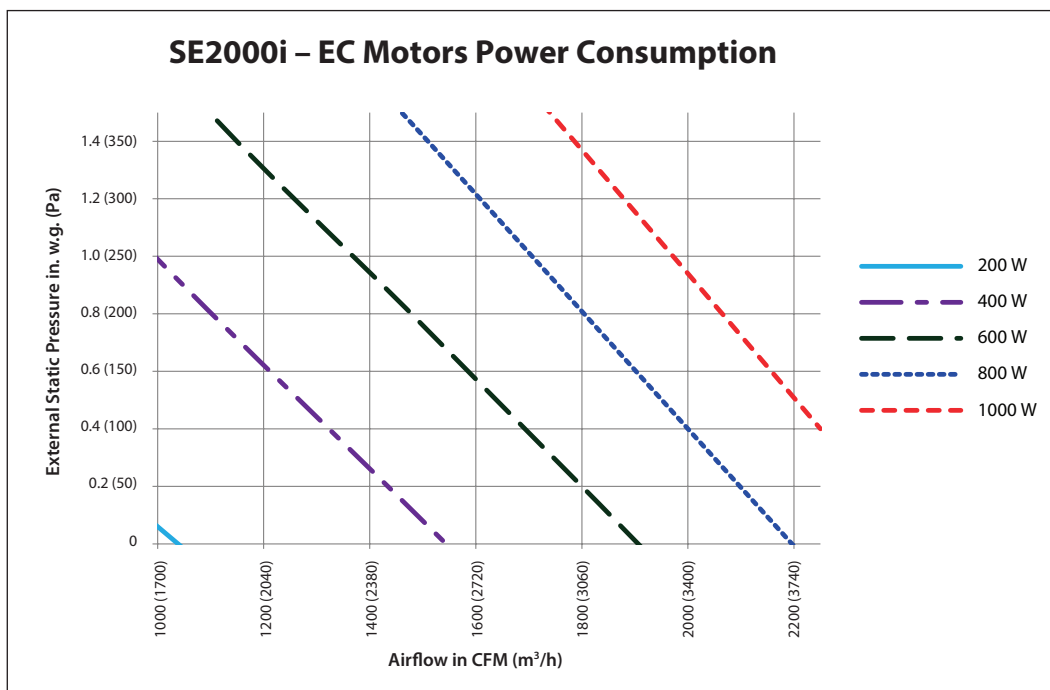

## Additional Air Pressure Drop with MERV 13 Filters

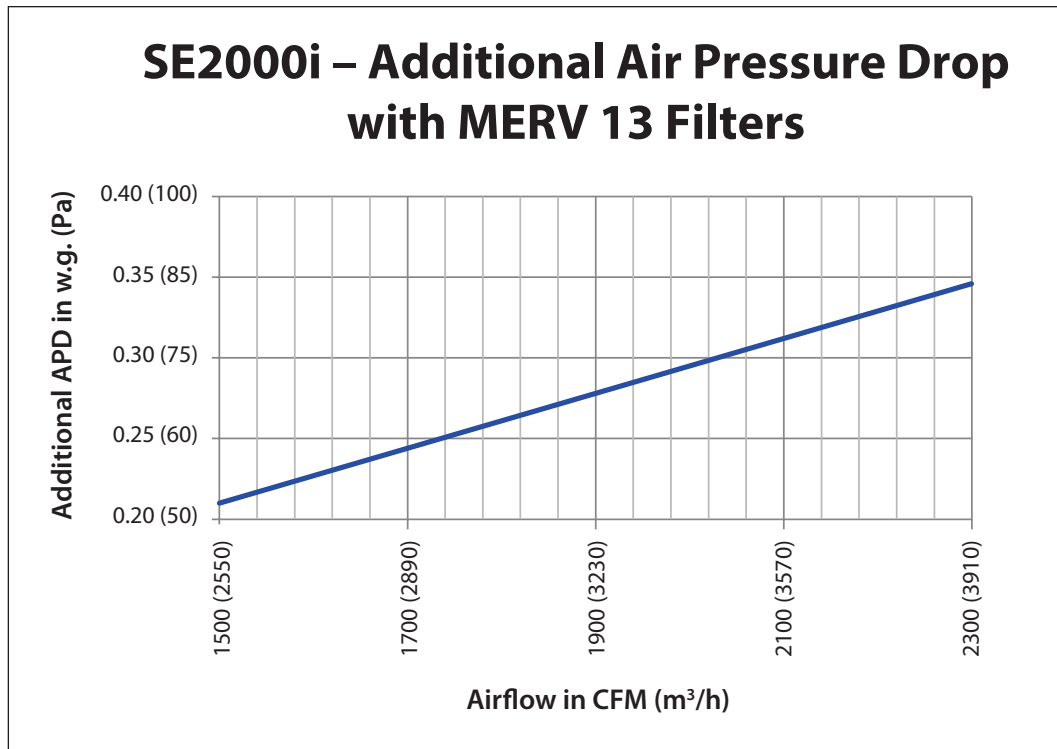

# Selection Information

▲ = Standard Feature

☐ = Optional Feature (check the box to select this option)

Send your completed selection to your American ALDES Representative.

## MODEL

Series: Standard Commercial (SE)  
 Nominal Capacity: 1000-2000 CFM  
 Application: Interior (i)

## CASING & CORE

### Cabinet Finish

- Galvanized
- Painted
- Pool Construction

### Duct Configuration (see pg. 4)

- 1-2-5-6
- 1-3-5-6
- 1-2-4-6
- 1-3-4-6

### Mirror Image Cabinet

- Optional

### Access Doors

- Fixed/Hinged
- Removable Panels

### Plate Exchanger

- Standard Enthalpy
- High-Efficiency Enthalpy
- High-Latent-Transfer Enthalpy

## FILTERS (SUPPLY)

- MERV 8
- MERV 13

## BLOWERS & MOTORS <sup>1</sup>

### Supply Blower

- 3/4 hp
- 1 hp
- 1.5 hp
- 2 hp
- 3 hp

### Exhaust Blower

- 3/4 hp
- 1 hp
- 1.5 hp
- 2 hp
- 3 hp

### Motor Type

- ODP
- TEFC
- EC Motors

### Speed

- Single Speed
- 2-Speed
- 2-Speed VFD
- Variable Speed Motor
- Variable Speed VFD

## ELECTRICAL REQUIREMENTS <sup>1</sup>

- 120V/1ph/60Hz
- 208V/1ph/60Hz
- 230V/1ph/60Hz
- 208V/3ph/60Hz
- 230V/3ph/60Hz
- 460V/3ph/60Hz
- 575V/3ph/60Hz

## DISCONNECT

- Non-Fused
- Fused

## FROST CONTROL

- None
- Exhaust Defrost <sup>2</sup>
- Recirculation <sup>2</sup>
- Pre-Heat (Electric Coil)
- Pre-Heat (Hot Water Coil)

## HEATING OPTIONS

- None
- Post-Heat (Electric Coil)
- Post-Heat (Hot Water Coil)

## ADD-ONS

- Motorized & Insulated Damper for OA <sup>2</sup>
- Motorized & Insulated Damper for EA
- Non-Insulated Backdraft Damper for EA
- 24 VAC, 10 VA terminals for OA and/or EA dampers by others
- 24 VAC, 20 VA power available for accessories by others
- Spare Filters QTY: \_\_\_\_\_
- Spare Belts QTY: \_\_\_\_\_

<sup>1</sup> See pg. 2 for motor and blower restrictions.

<sup>2</sup> OA Motorized & Insulated Damper included

Project:		Architect:	
Location:		Engineer:	
Model #:		Contractor:	
Quantity:		Comments:	
Submitted By:			
Date:			